

2/2-way valves DN 8 to DN 50
for neutral gaseous and liquid fluids
Indirectly solenoid actuated
Diaphragm valves
Internal threads G 1/4 to G 2 or 1/4" NPT to 2" NPT
Operating pressure 0.1 to 10/16 bar

Click-on®

82400
82410

Description (standard valve)

Solenoid valve for e.g. air, water

Switching function:	Normally closed
Flow direction:	determined
Fluid temperature:	-10 °C to max. +90 °C
Ambient temperature:	-10 °C to max. +50 °C
Mounting position:	optional, preferably solenoid vertical on top



Material

Body:	Brass
Seat seal:	NBR
Internal parts:	Stainless steel, PVDF resp. brass

For contaminated fluids insertion of a strainer is recommended (see accessories).

Features

- High flow rate
- Damped operation
- Clear compact design
- Solenoid interchangeable without tools (Click-on®)
- Especially qualification as water valve to DIN EN 60730-2-8

EC type examination up to ND 25

acc. to DIN EN 60730-2-8

Solenoid Valves

Test laboratory

TÜV Rheinland / Brandenburg

Symbol

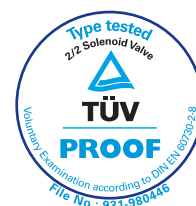
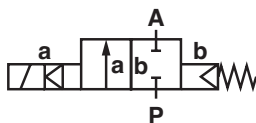

Ordering information

To order, quote model number from table overleaf, e.g. 8240000.9101 for a G 1/4 valve with standard solenoid.

Characteristic data

See page 2 valve and solenoid informations

Detmolder Strasse 256
D-32545 Bad Oeynhausen

PO Box 10 02 52-53
D-32502 Bad Oeynhausen

Phone ++49 5731 / 7 91-0
Fax ++49 5731 / 791-179

<http://www.buschjost.com>
mail@buschjost.de

Characteristic data

Valves

Part Number with DC or AC solenoid	Nominal Diameter (mm)	Port size	Valve length (mm)	Operating Pressure *		k _v -value ** (Base m ³ /h)	Weight (kg)
				min	max (bar)		
8240000.9101 8241000.9101	8	G 1/4 1/4" NPT	60	0.1	16	1.90	0.47
8240100.9101 8241100.9101	10	G 3/8 3/8" NPT	60	0.1	16	3.00	0.45
8240200.9101 8241200.9101	12	G 1/2 1/2" NPT	67	0.1	16	3.80	0.50
8240300.9101 8241300.9101	20	G 3/4 3/4" NPT	80	0.1	16	6.10	0.65
8240400.9101 8241400.9101	25	G 1 1" NPT	95	0.1	16	9.50	0.95
8240500.9101 8241500.9101	32	G 1 1/4 1 1/4" NPT	132	0.1	10 (16***)	23.00	2.73
8240600.9101 8241600.9101	40	G 1 1/2 1 1/2" NPT	132	0.1	10 (16***)	25.00	2.53
8240700.9101 8241700.9101	50	G 2 2" NPT	160	0.1	10 (16***)	41.00	3.85

State voltage [V] and frequency [Hz]

* with gaseous and liquid fluids up to 25 mm²/s (cSt)

** C_v-value (US) ≈ k_v-value x 1.2

*** with solenoid 9151

9101/9151 Solenoid

Standard voltages

DC	AC	
	50 Hz	60 Hz
24 V	24 V	–
–	110 V	120 V
205 V	230 V	220 V

Design acc. to DIN VDE 0580

Voltage range ±10 %



100 % duty cycle

Protection class acc. to EN 60529 IP65

Socket acc. to DIN EN 175301-803 (included)

Power Consumption

According to DIN VDE 0580 at coil temperature +20 °C. In operating the solenoid coil decrease the power consumption appr. 30 %.

DC	AC	
	Inrush	Holding
9101 8 W 	15 VA	12 VA / 7 W
9151 18 W 	45 VA	35 VA / 17 W

For technical details see catalog-register "Solenoids"

Options (Valves)

- XXXXX01.XXXX Normally open (NO);
from G 1 1/4 with solenoid 9151; 0.1 up to 16 bar
- XXXXX02.XXXX Manual override
- XXXXX03.XXXX Seat seal FPM,
max. fluid temperature +110 °C
- XXXXX14.XXXX Seat seal EPDM, for hot water,
max. fluid temperature +110 °C;
0.3 to 16 bar up to DN 25
0.3 to 10 bar from DN 32
- XXXXX50.XXXX Latching system; impulse time min. 30 ms;
only for DC 6, 12 and 24 V

On request

Further versions

Options (Solenoids)

- XXXXXXXX.9136 Solenoid in protection class
 II 2 GD EEx m II T4 T 110 °C
with 3 m connection cable, for AC/DC

Section View

to G 1 e.g. 1" NPT

up to G 1 1/4 e.g. 1 1/4" NPT

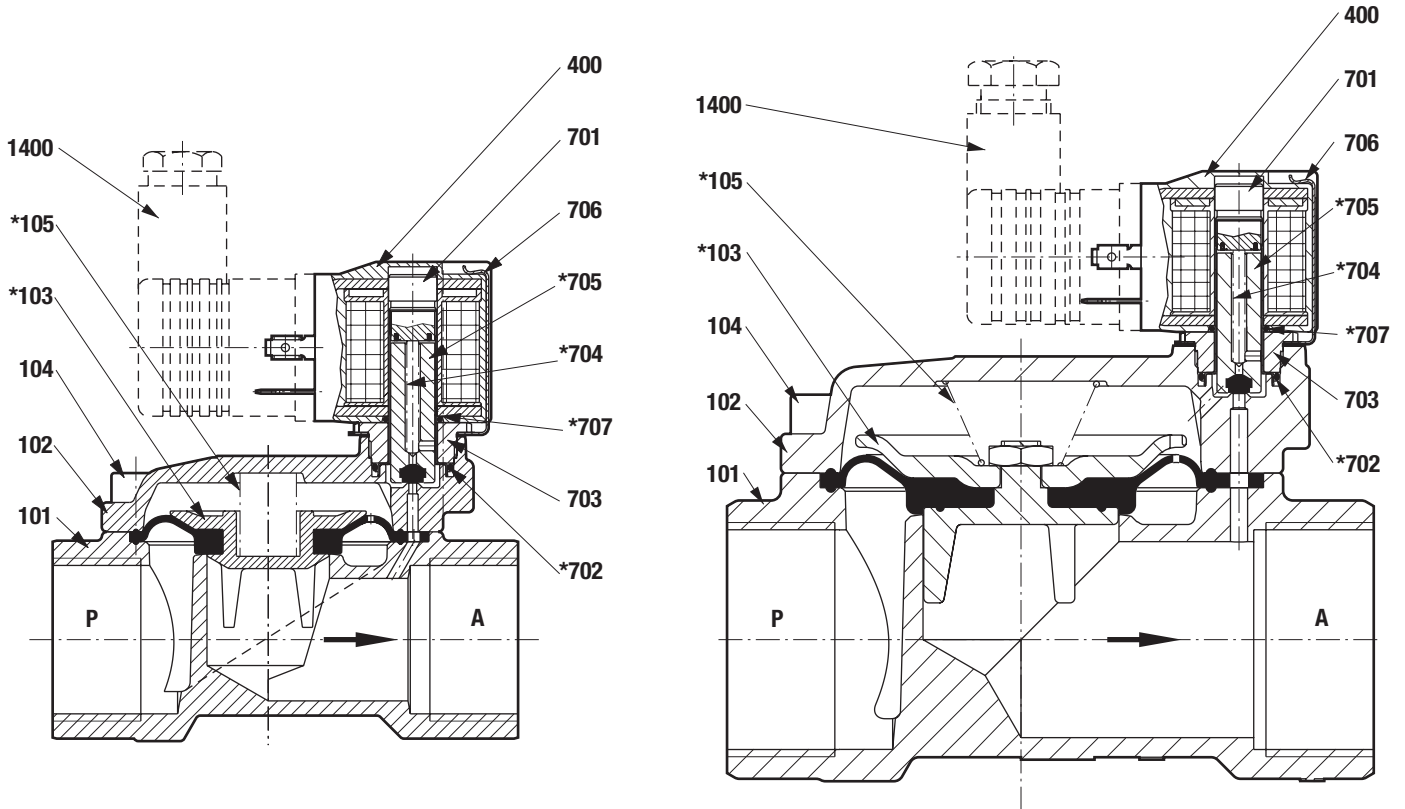

- 101 Valve body
- 102 Valve cover
- *103 Diaphragm
- 104 Socket head cap screw
- *105 Pressure spring
- 400 Solenoid
- 701 Core tube
- *702 O-ring
- 703 Screw piece
- *704 Pressure spring
- *705 Core
- 706 Spring clip
- *707 O-ring
- 1400 Socket (included)

* These individual parts form a complete wearing unit.
When ordering spare parts please state Cat no and series no.

General Dimensions

Solenoid rotatable 360°
 Socket turnable 4 x 90°
 (Socket included)

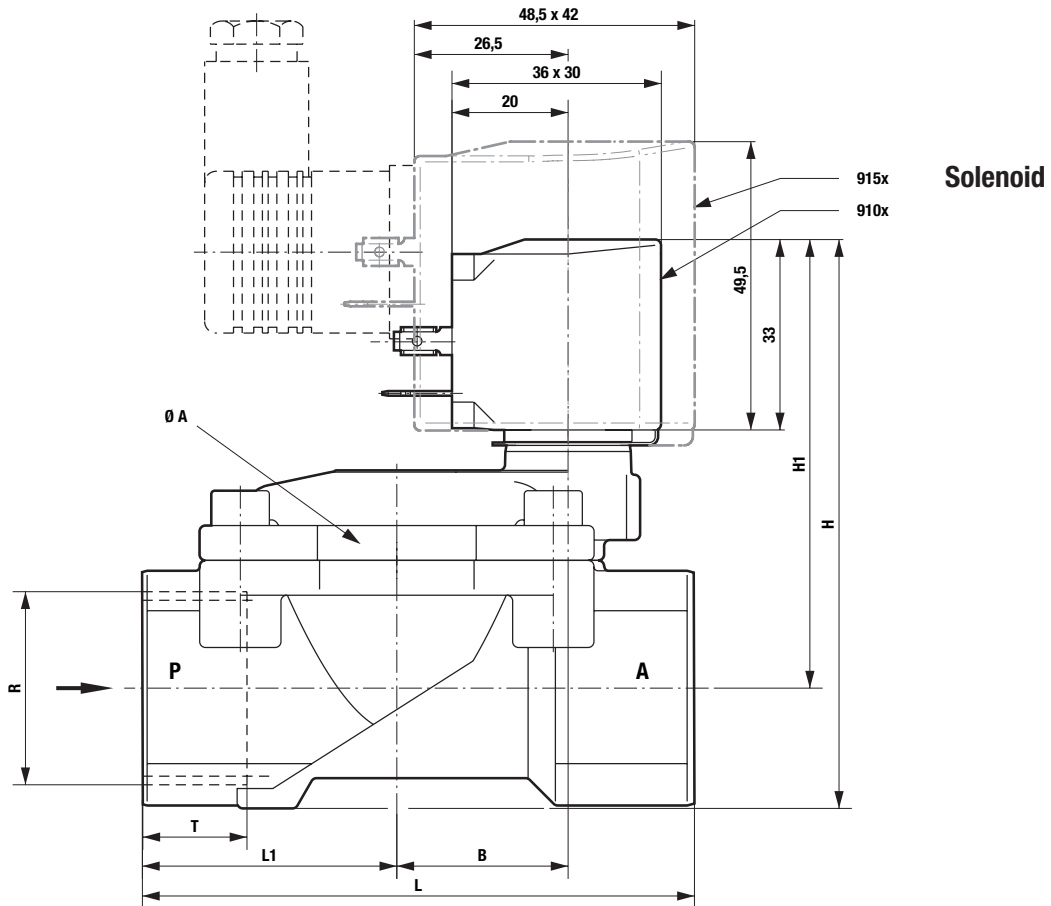

Part Number	Ø A	B	H	H1	L	L1	R	T
8240000.9101	44	19.5	78.5	67.0	60	27.5	G 1/4	12.0
8241000.9101							1/4" NPT	10.0
8240100.9101	44	19.5	78.5	67.0	60	27.5	G 3/8	12.0
8241100.9101							3/8" NPT	10.5
8240200.9101	44	19.5	81.0	67.0	67	31.0	G 1/2	14.0
8241200.9101							1/2" NPT	13.5
8240300.9101	50	24.0	88.0	71.5	80	36.5	G 3/4	16.0
8241300.9101							3/4" NPT	14.0
8240400.9101	62	29.5	97.5	77.0	95	44.0	G 1	18.0
8241400.9101							1" NPT	17.0
8240500.9101	92	44.5	124.5	95.5	132	60.0	G 1 1/4	20.0
8241500.9101							1 1/4" NPT	17.0
8240600.9101	92	44.5	124.5	95.5	132	60.0	G 1 1/2	22.0
8241600.9101							1 1/2" NPT	17.0
8240700.9101	109	54.5	142.5	108.0	160	74.0	G 2	24.0
8241700.9101							2" NPT	17.5

Note to Pressure Equipment Directive (PED):

The valves of this series, including the connection-size DN 25 (G 1), are according to Art. 3 § 3 of the Pressure Equipment Directive (PED) 97/23/EG. This means interpretation and production are in accordance to engineers practice wellknown in the member countries.

The CE-sign at the valve refers not to the PED. Thus the declaration of conformity is not longer applicable for this directive.

For valves > DN 25 (G 1) Art. 3 § (1) No.1.4 applies.

The basic requirements of the Enclosure I of the PED must be fulfilled. The CE-sign at the valve includes the PED. A certificate of conformity of this directive will be available on request.

Note to Electromagnetic Compatibility Guideline (EEC):

The valves shall be provided with an electrical circuit which ensures the limits of the harmonised standards EN 50081-1 and EN 50082-1 are observed, and hence the requirements of the Electromagnetic Compatibility Guideline (89/336/EEC) satisfied.